

HEPA-AIRE PORTABLE AIR SCRUBBER-PAS1800

INSTRUCTION MANUAL

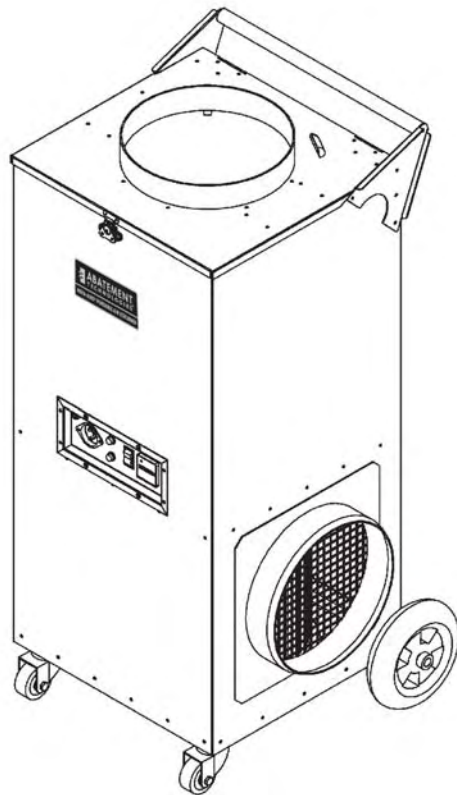

Abatement Technologies, Inc./Remediation Products Division

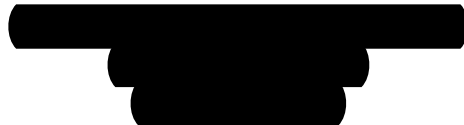
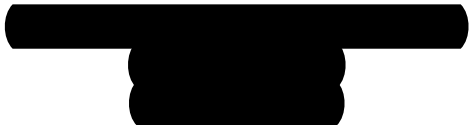

THE HEPA-AIRE® PAS1800 PORTABLE AIR SCRUBBER

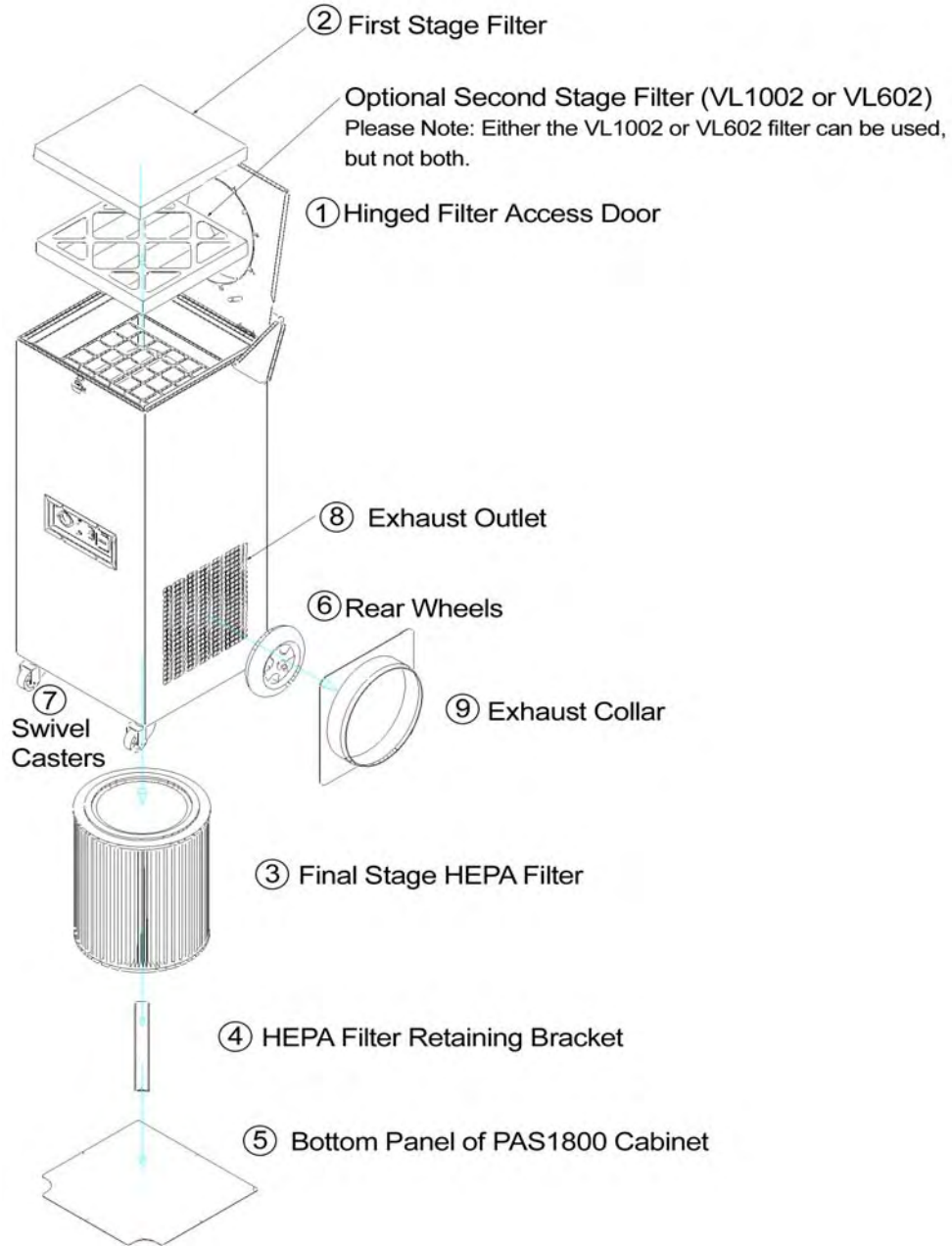

- | | |
|--|------------------------------------|
| 1. Hinged Filter Access Door | 5. Bottom Panel of PAS1800 Cabinet |
| 2. First Stage Filter (P/N F2221)
(a) Optional Second Stage filter
(P/N VL1002 or VL602) | 6. 8" Rear Wheels |
| 3. Final Stage 99.97% HEPA Filter
(P/N H1210C-99) | 7. 360° Swivel Casters |
| 4. HEPA Filter Retaining Bracket | 8. Exhaust Outlet |
| | 9. Exhaust Collar |

HEPA-AIRE® PORTABLE AIR SCRUBBER - PAS1800

© Abatement Technologies 2001 All Rights Reserved. No reproduction of any portion of this work is permitted without the express written permission of Abatement Technologies, Inc.

Note:

- 1. Read and understand all operating instructions before using the PAS1800 Portable Air Scrubber.**
- 2. Save this manual for future reference.**

This instruction manual provides important information on the use of the HEPA-AIRE Portable Air Scrubber PAS1800 unit. These instructions must be carefully followed in order to operate the unit safely and correctly. If there are any questions regarding the use of the unit, please contact Abatement Technologies, Inc. immediately at 800-634-9091 U.S. or 905-871-4720 Canada.

GENERAL INFORMATION

The PAS1800 is a multi-use air filtration unit capable of filtering most airborne particulates and odors, vapors, and gases (O/V/G) with final stage filtration through a High Efficiency Particulate Air (HEPA) filter.

Types of contaminants captured:

- Dirt
- Dust
- Drywall Dust
- Saw Dust
- Lung-Damaging Particles
- Molds and Fungi
- Gases, VOC, Odors and Smoke (with use of optional carbon filter)

The PAS1800 is designed for indoor operation only.

The PAS1800 is engineered for easy transport to and within the project site. It incorporates a series of particulate filters which successively remove larger size to smaller size particles from the air.

An optional activated carbon filter (VL1002 or VL602) can be used to adsorb odors, vapors and gases and remove particulates. The process of adsorption retains the O/V/G molecules within the pores of the carbon granules.

Effective removal of various odors, vapors, and gases relies on the removal of the emission source, and the air-scrubbing of the ambient air containing the airborne O/V/G contaminants. By recirculating the ambient air within the project area, the air is filtered and returned to mix with the rest of the room air.

The PAS1800 is equipped with a two speed motor and filters between 1000-1800 cubic feet of air per minute with clean filters (first stage and HEPA) and without the attachment of flexible duct. As a guide, the following formula may be used when calculating the total air recycling time (one air change) in a closed environment (assuming no intake of additional air):

$$\frac{\text{Volume of enclosed area (cubic feet)}}{\text{CFM of PAS1800}} = \text{Number of minutes required to filter the area air through the PAS1800 one time.}$$

EXAMPLE:
$$\frac{\text{Room size of } 40' \text{L} \times 30' \text{W} \times 10' \text{H} = 12000 \text{ cu.ft.}}{1800 \text{ cu.ft. min.}} = \frac{12000 \text{ cu.ft.}}{1800 \text{ cu.ft. per min.}} = 6.7 \text{ min. for 1 air change}$$

Or
9.0 air changes per hour

Effective carbon filtration is dependent upon the amount of contact time that the O/V/G molecules have with the carbon filter media. As the PAS1800 draws air through the media, the air is "scrubbed" as these molecules adhere to the surfaces of the carbon granules. Repeated recirculation of air through the unit reduces the O/V/G concentration. There is no "rule of thumb" for determining the length of time required for an area to be cleaned of ambient odors, vapors, or gases. Unknown variables such as concentration, intake volume of fresh air, temperature, humidity, and other factors prevent the accurate estimation of carbon filter life. For odorous substances, the evidence of a clean, air-scrubbed environment is the absence or greatly reduced presence of the O/V/G. Air quality testing should be conducted if the source is unknown, the vapors are toxic and/or otherwise hazardous to health, and to confirm that substances are not present at harmful levels.

The PAS1800 can be equipped with inlet and exhaust collars which accept 12" diameter flexible or rigid duct. The inlet collar is useful for filtration of particulates and O/V/G in remote areas. The removable exhaust collar is used to direct the unit's exhaust to remote areas. For optimum air-scrubbing, operate the PAS1800 in the center of the open area, allowing for more free-air movement.

PAS1800 TRANSPORT

Note: The PAS1800 can be transported in the horizontal position. If extremely poor road conditions exist, or excessive shock and vibration are expected, take precautionary measures by padding the unit to provide impact absorption during transport.

Caution: Always use caution when moving the PAS1800 inside a building or home. The unit weighs 138 pounds. Older structures with weakened floors or staircases may require special considerations for safe transport.

PAS1800 OPERATION

Note: To maximize the unit's airflow performance, always use the shortest length of flexible duct necessary. This applies to flex duct connected to the inlet. Use of excess flex duct will dramatically reduce machine airflow. The flexible duct should be as tight (around inlet collar on unit) and straight as possible (to avoid airflow loss from bends).

In the PAS1800, each filter contributes to the total filtering efficiency of the system. The incoming air passes through a 2" thick first stage prefilter. There are optional second stage filters that can also be used for additional particulate and O/V/G filtration - See PAS1800 Specifications page. In addition, refer to the chart at the end of this manual entitled "Activated Carbon Adsorbency of Selected Substances and Odors". Large particles are retained by the prefilter(s). The air then passes through the HEPA filter which captures 99.97% of all particles 0.3 microns and larger in size.

ELECTRICAL REQUIREMENTS

- 1. For maximum safety, the PAS1800 should always be connected to a three-prong grounded 115 volt/15 amp electrical outlet equipped with a Ground Fault Circuit Interrupter (GFCI) device. To reduce risk of fire or electrical shock, do not use the PAS1800 with any solid state speed control device. Do not use in a cooking area.**

Caution: To avoid damage to the PAS1800 electrical system and power cord, do not connect or disconnect a power cord to an electrical outlet unless the power switch is in the "OFF" position.

2. All electrical equipment used on the job must be in good condition and properly grounded. Check all outlets, wiring, extension cords, and the ground pin on plugs.
3. Extension cords used for the PAS1800 must be the heavy duty No. 14/3 AWG industrial grade 3-wire type, in good condition and in continuous lengths (no splicing). Power cords should not exceed a total of 50' in length.

Note: Use of a higher numerical gauge (lower capacity wire) power cord will not satisfy amperage requirements of motor, and may result in electrical hazards, personal injury and/or damage to the motor.

Caution: The HEPA-AIRE PAS1800 requires a minimum of 110 volts to operate properly. Make certain that any extension cords used do not reduce power to the machine to less than 110 volts. Use of a voltmeter to confirm adequate voltage is recommended.

4. Due to momentary start-up current surge, the unit requires a 15 amp circuit which is free of other loads.
5. If unit is connected to a circuit protected by fuses, use time delay fuses.

REQUIREMENTS FOR SAFE OPERATION

1. Never allow unauthorized individuals or children to operate the unit at any time.
2. Abatement Technologies urges anyone operating the PAS1800 to wear the proper personal protective equipment in accordance with federal, state and employer regulations.

3. Check condition of power cord(s) before using them. Damaged cords can cause fatal electrical shock and/or motor failure.
4. **As with any piece of electrical equipment, be sure that the unit Power Switch is "OFF" prior to connecting or disconnecting an energized power cord to the unit's Power Cord Connection receptacle. Failure to do so will cause "arcing" and damage unit.** Never pull on an energized power cord to disconnect it from an outlet. Always disconnect the power cord from the electrical outlet disconnecting the cord from the Power Cord Connection receptacle on the control panel.
5. Do not touch the electrical outlet or power cord(s) with wet hands or while standing on a wet or damp surface.
6. Power cord(s) should never be exposed to water, heat, sharp, or abrasive objects; in addition, they should never be kinked or crushed.
7. Never pull the unit by the power cord.
8. Avoid running over power cords with utility equipment and vehicles.
9. Avoid tightly wrapping the cords to prevent kinking of the internal wires.
10. Always replace damaged cords immediately.

Warning: To reduce risk of electrical shock, do not expose this unit to water or rain.

Warning: Risk of electrical shock! Can cause injury or death. Turn unit "OFF" and disconnect power supply cord before servicing unit.

CAUTION: For General Ventilating Use Only. Do not use to exhaust Hazardous Or Explosive Materials And Vapors.

Warning: Any atmosphere that is combustible, flammable, explosive, oxygen deficient, and/or contains odors, vapors, gases or particulates that exceed permissible exposure levels should be evaluated by a certified industrial hygiene professional before being occupied. Such atmospheres may require the use of intrinsically safe equipment, specific engineering controls, and personal protective equipment in accordance with Occupational Safety and Health Administration (OSHA), Environmental Protection Agency (EPA), Canadian Standards Association (CSA), and other federal, state, provincial and local regulations.

Warning: This equipment is not classified as "intrinsically safe" and should not be used in the following potentially hazardous locations as defined by the Underwriters Laboratories: Class I Division I, Class I Division 2, Class 1 Zone 0, Class 1 Zone 1, Class 1 Zone 2, Class II Division 1, Class II Division 2, Class III Division 1, Class III Division 2. Refer to the UL web site: <http://www.ul.com/hazloc/define.htm>.

BEFORE OPERATING THE UNIT NOTE THE FOLLOWING:

Inspect and tighten any HEPA filter retaining bolts that may have loosened during transportation. Inspect each filter for any material or structural damage prior to each use. Replace any damaged filters before operating the PAS1800. When removing any filters prior to operation, always replace with air flow indicator on filter housing oriented in the proper direction (if applicable).

The PAS1800 is equipped with a removable exhaust collar. In order to attach the PAS2012 collar to the PAS1800, slide the collar into the offset tabs bordering the exhaust outlet. Fasten the collar to the unit with two screws.

PAS1800 CONTROL PANEL

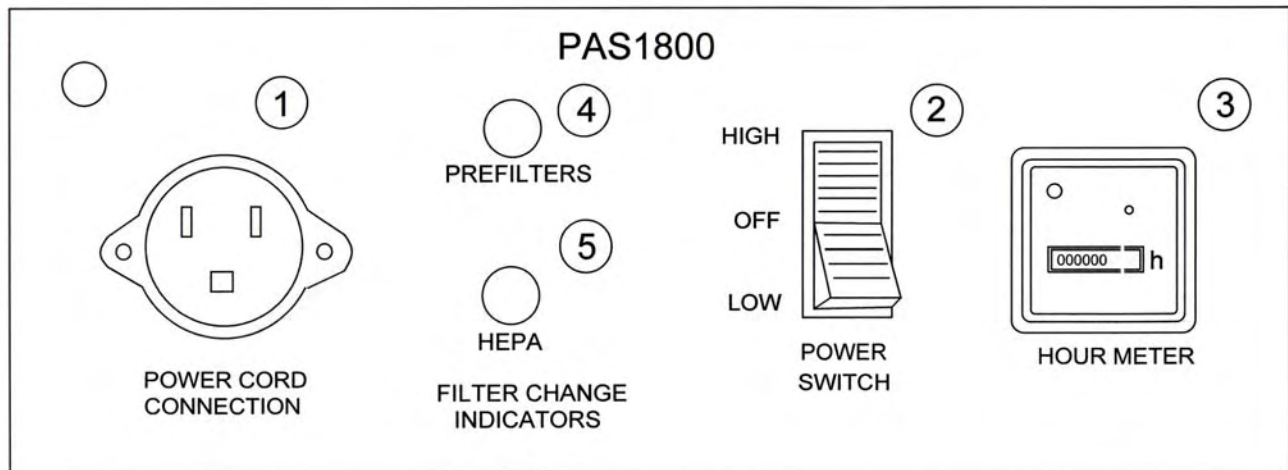

- 1. Power Cord Connection Receptacle** - Electrical receptacle for connection of power cord.
- 2. Power Switch** - Three position switch: High Speed, Off, Low Speed.
- 3. Hour Meter** - Provides a count of the total operating hours.
- 4. Filter Change Indicator - Prefilters** - Indicates excessive restriction on intake or loading of the first stage filter (and/or second stage filter, if one is being used) and that filter change procedures should be followed.
- 5. Filter Change Indicator - HEPA** - Indicates excessive restriction on exhaust or loading of the HEPA filter and that filter change procedures should be followed.
Note: Both Filter Change Indicators should be checked when the unit is operating on "HIGH" speed.

TO START UNIT

- Check to make sure the Power Switch is in the "OFF" position. Plug a 14/3 AWG power cord into the Power Cord Connection receptacle on the control panel and into a 115 volt supply circuit.
- Set Power Switch to high or low speed.

FILTER CHANGE INDICATORS

Prefilters light "ON" indicates one or more of the following:

- Loaded first stage filter (and/or optional second stage filter if one is being used) is loaded. Refer to filter change procedures.
- Restrictions on air intake. Refer to Troubleshooting Guide.

HEPA Light "ON" indicated one or more of the following:

- Loaded HEPA filter. Refer to filter change procedures.
- Restrictions on exhaust. Refer to Troubleshooting Guide.

FILTER REPLACEMENT

Note: Personnel responsible for changing filters are urged to wear NIOSH approved respirators and other personal protective equipment in accordance with employer, state, and federal regulations.

Note: The filters are not reusable, therefore, do not attempt to clean and reuse them.

Caution: Abatement Technologies PAS1800 Portable Air Scrubber units are designed to meet or exceed standards for high efficiency air filtration equipment.

Use only Abatement Technologies parts, including replacement prefilters and HEPA filters. Use of non-Abatement Technologies parts and filters voids the product warranty and all performance claims.

System air flow reduction is generally the result of filter loading, blockage of the unit's inlet or use of excessive lengths of flex duct connected to the inlet.

The size and concentration of airborne contaminants, temperature and humidity conditions, and duration of use determine how often filters need replacement. If the Filter Change Indicator(s) on the control panel illuminate, this indicates one or more of the following: (1) the first stage filter is loaded, (2) the optional second stage filter (if one is being used) is loaded, (3) the inlet is obstructed, (4) the exhaust is obstructed, (5) the flex duct, if any, is too long or has too many bends and (6) the HEPA filter is loaded.

The method of determining when to replace the optional carbon filter is somewhat subjective. As the odor, vapor, and/or gas filtration capacity decreases, the user will begin to sense a slight odor or taste of the contaminant, indicating that the filter should be replaced.

FILTER CHANGE PROCEDURE

To Change the Prefilter(s):

1. With the unit operating, open the prefilter access door.
2. Remove the first stage filter and replace it with a new one.
3. Close the filter access door and lock it in position.
4. If the filter change indicator for the prefilters remains "ON" after changing the first stage filter, the optional second stage filter should be replaced.

To Change the HEPA Filter:

1. Turn the unit "OFF" and disconnect the power cord from the electrical outlet and the power cord connection receptacle on the control panel.
2. Lay the unit on its back side and remove the bottom panel of the cabinet. The bottom panel is secured in place with screws.
3. Using a 7/16" wrench, loosen the HEPA filter retaining bolt closest to the front of the unit by turning it in a counterclockwise direction. Once the front bolt is removed, the rear bolt and HEPA filter retaining bracket can be easily removed. Remove the HEPA filter and dispose of it.
4. Inspect the gasket on the new HEPA filter; make sure there are NO cracks, gaps or defects. Cracks, gaps and defects could permit leakage of contaminated air through the unit. When installing the HEPA filter, make sure **THE GASKET END OF THE HEPA IS PLACED INTO THE UNIT FIRST**. Position the HEPA filter inside the tabs affixed to the PAS1800. Replace the retaining bracket and tighten the bolts. Do not overtighten.
5. Replace the first stage filter (and second stage filter if one is being used), close the filter access door and lock it in position. Reinstall the bottom panel of the cabinet and secure it in place with its screws.

PAS1800 SPECIFICATIONS

FEATURE	PAS1800
Net weight w/filters:	138 lbs.
Shipping weight:	160 lbs.
Dimensions (LxWxH):	24 1/2"W x 21 1/2"D x 45 1/2"H
Power supply requirements:	115 volts, 15 amps
Normal operating amps:	10 amps or less
Motor:	1 3/4 H.P. Motor with thermal overload protection, auto re-set, 60 Hz, single phase.
Automatic restart:	Motor will automatically restart itself after temporary power interruption.
Operating flow rate: (with clean filters)	1000 - Low Speed 1800 - High Speed
Operational sound level:	66 to 71 dBA, reading taken at 5 feet
Cabinet material:	20 gauge stainless steel
Cabinet seams:	Solid rivets and gaskets
Transportability:	2 each 8" rubber wheels in rear and 2 ea. 360° swivel casters in front.
Prefilter access:	Easy-operating hinged door is secured by a Cam-Lock latch.
First stage prefilter:	2" particulate prefilter
Second stage prefilter (optional):	2" particulate/carbon filter (VL1002 or VL602)
HEPA filter:	DOP tested and certified to be 99.97% efficient against 0.3 micron size particles.

Note: Specifications subject to change without notice.

TROUBLE SHOOTING GUIDE

PROBLEM	POSSIBLE CAUSE	SOLUTION
NO RESPONSE WHEN THE POWER IS TURNED "ON"	<ul style="list-style-type: none"> -POWER CORD UNPLUGGED -DEFECTIVE POWER CORD. -TRIPPED CIRCUIT BREAKER. -TRIPPED GROUND FAULT CIRCUIT INTERRUPTER. -THERMAL OVERLOAD ON THE MOTOR HAS TRIPPED. 	<ul style="list-style-type: none"> -PLUG POWER CORD FIRMLY INTO ELECTRICAL OUTLET IN WALL. -CHECK ALL CONNECTIONS AND CONDITION OF ALL CORDS. DO NOT OPERATE WITH DAMAGED POWER CORD(S). -RESET BREAKER FOR BUILDING. -RESET GFCI AT POWER SOURCE. -TURN UNIT "OFF", WAIT 30 MINUTES AND RESTART UNIT.
UNIT RUMBLES WHEN ATTEMPTING TO START.	<ul style="list-style-type: none"> -LOW VOLTAGE OR LIMITED AMPERAGE IS SUPPLIED. -EXTENSION CORD IS TOO LONG OR OF TOO HIGH GAUGE. -OTHER MACHINES OR LOADS ON SAME CORD OR CIRCUIT. 	<ul style="list-style-type: none"> -CHECK POWER SUPPLY-UNIT REQUIRES 115V 15 AMP CIRCUIT WHICH IS LOAD FREE. -EXTENSION CORD(S) SHOULD NOT EXCEED A TOTAL OF 50 FT IN LENGTH. USE GROUNDED 3-WIRE 14 GAUGE CORD(S). -REMOVE OTHER LOADS FROM SAME CIRCUIT.
FILTER CHANGE INDICATOR(S) "ON"	<ul style="list-style-type: none"> -LOADED FIRST, OPTIONAL SECOND STAGE AND/OR HEPA FILTER. -CARBON FILTER PACK HAS NOT BEEN REMOVED FROM POLYBAG. -EXCESSIVE RESTRICTIONS ON INTAKE OR EXHAUST. 	<ul style="list-style-type: none"> -CHANGE IN ACCORDANCE WITH OPERATING INSTRUCTIONS. -REMOVE CARBON FILTER PACK FROM POLYBAG. -REDUCE BENDS, LENGTH OF FLEX DUCT OR ELIMINATE RESTRICTIONS.

Note: If the unit does not start or malfunctions after carefully following the Troubleshooting Guide, call Abatement Technologies at 800-634-9091 for assistance.

COMPONENT REPLACEMENT

Occasionally a defective component will cause the unit to operate improperly or not at all. Any electrical device can fail. Refer to the WIRING SCHEMATIC OR WIRING DIAGRAM to diagnose the failure of any component. Diagnostics should only be performed by a qualified technician.

Warning: Use only Abatement Technologies prefilters, HEPA filters, and replacement parts. Substitute parts void the warranty, jeopardize worker and environmental safety, and adversely affect engineered performance levels.

REMOVAL OF THE CONTROL PANEL FOR SERVICING

Caution: Always turn off unit and disconnect it from the power source before removing the control panel, or replacing the HEPA filter.

The control panel of the PAS1800 machine is modular allowing for easy access and servicing. All control panel components are wired with 1/4" quick connect terminals.

LIMITED WARRANTY

Abatement Technologies, Inc (ATI) warrants that goods sold to the original user shall be free from defects in material and workmanship for a period of 1 year, except such as are commercially acceptable. This warranty does not include useful filter life. **ATI does not warrant that the goods sold are merchantable or fit for any particular purpose. ATI makes no warranties other than as stated in this paragraph. All other warranties, guaranties, or representations, express or implied, by operation of law or otherwise, are expressly disclaimed.** Goods found by ATI to be defective or not to conform to specification shall upon return be replaced or repaired by ATI without any additional charges, or, at ATI's option, ATI may refund the purchase price of such goods. ATI will pay return transportation charges on returned goods not exceeding the transportation charges applicable to shipment from original destination unless the returned goods are free from defect and conform to specifications. Returned goods which are found by ATI to be free from defect and to conform to specifications shall be held for Purchaser's shipping instructions, which instructions Purchaser shall furnish promptly upon request. **ATI's liability shall in no event extend beyond replacement, repair or refund of the purchase price and ATI shall not be liable under any circumstances for special, contingent or consequential damages, nor for loss, damages, or expenses directly or indirectly arising from the use of the goods, including without limitation, warehousing, labor, handling and service charges, die, equipment, or machine breakage, nor for costs, lost profits or loss of good will. The use of substitute, non-ATI parts and/or filters, in any ATI product, voids all warranties and performance claims. The remedies set forth herein are exclusive.**

For warranty information and assistance contact Abatement Technologies' Customer Service Department at 800-634-9091 (U.S.) or 905-871-4720 (Canada.)

Abatement Technologies' HEPA-AIRE® and HEPA-CARE® high-efficiency air filtration units are originally equipped with true HEPA (High Efficiency Particulate Air) filters designed to maximize the performance of the equipment, and to meet the following industry standards:

Institute of Environment Sciences and Technology

IEST-RP-CC001.3 (Type A HEPA and ULPA Filters)

IEST-RP-CC021.1 (Testing HEPA and ULPA Filter Media)

Underwriters Laboratories

UL900, Class II (Flammability Specifications)

100% Efficiency Tested

Abatement Technologies HEPA filters are individually tested and certified to ensure that the completed filter provides an overall minimum efficiency of 99.97% when challenged by a thermally generated test aerosol 0.3-microns in size, in accordance with IEST-RP-CC001.3.

Caution: Do Not Substitute

Use only Abatement Technologies filters in this product. Substitution of other filters may reduce the unit's filtration efficiency, airflow and filter life, and voids all related performance claims and product warranties.

PAS1800 WIRING SCHEMATIC

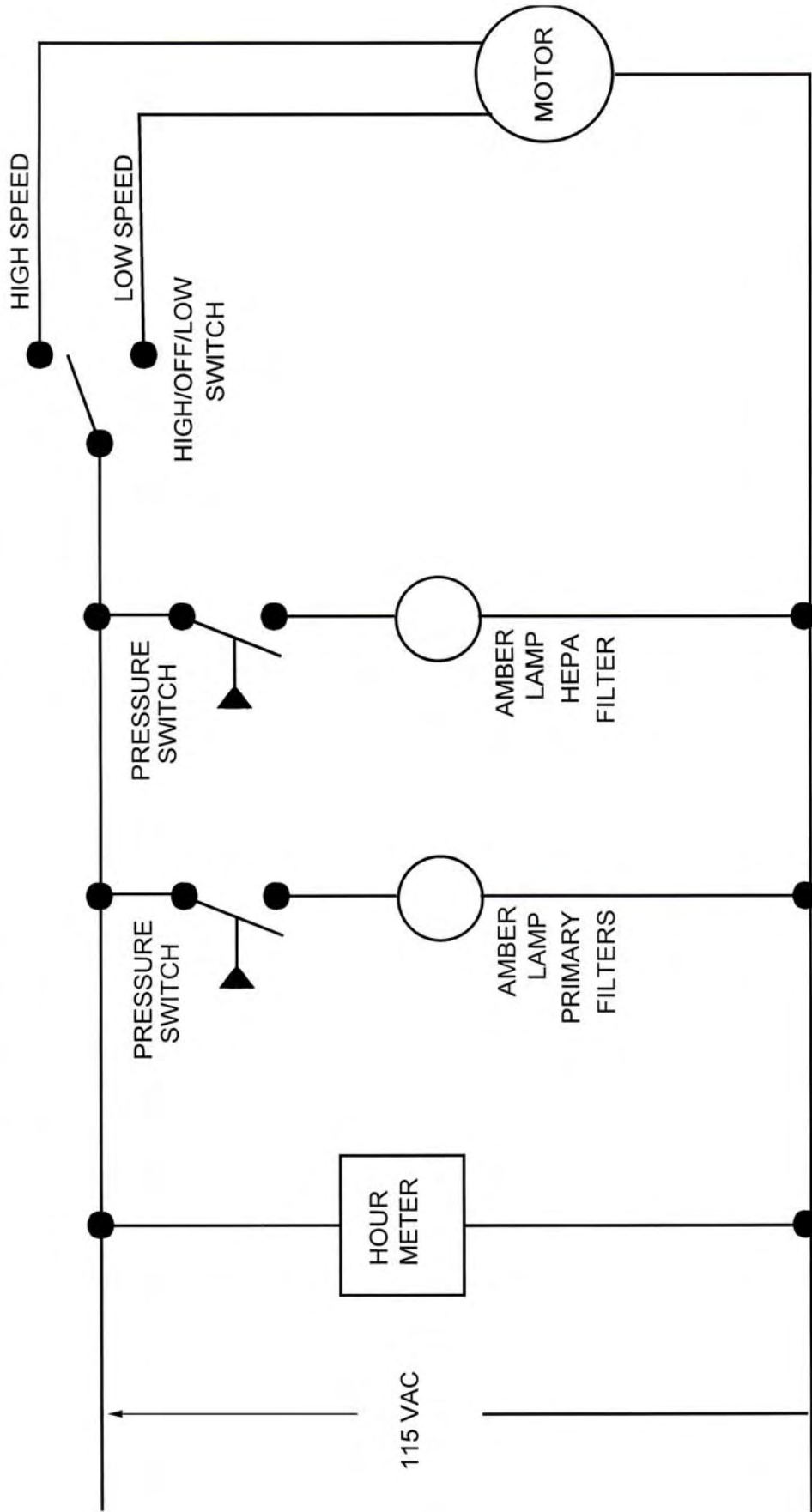

PAS18SC2.DC2
MARCH 2003

PAS1800 WIRING DIAGRAM

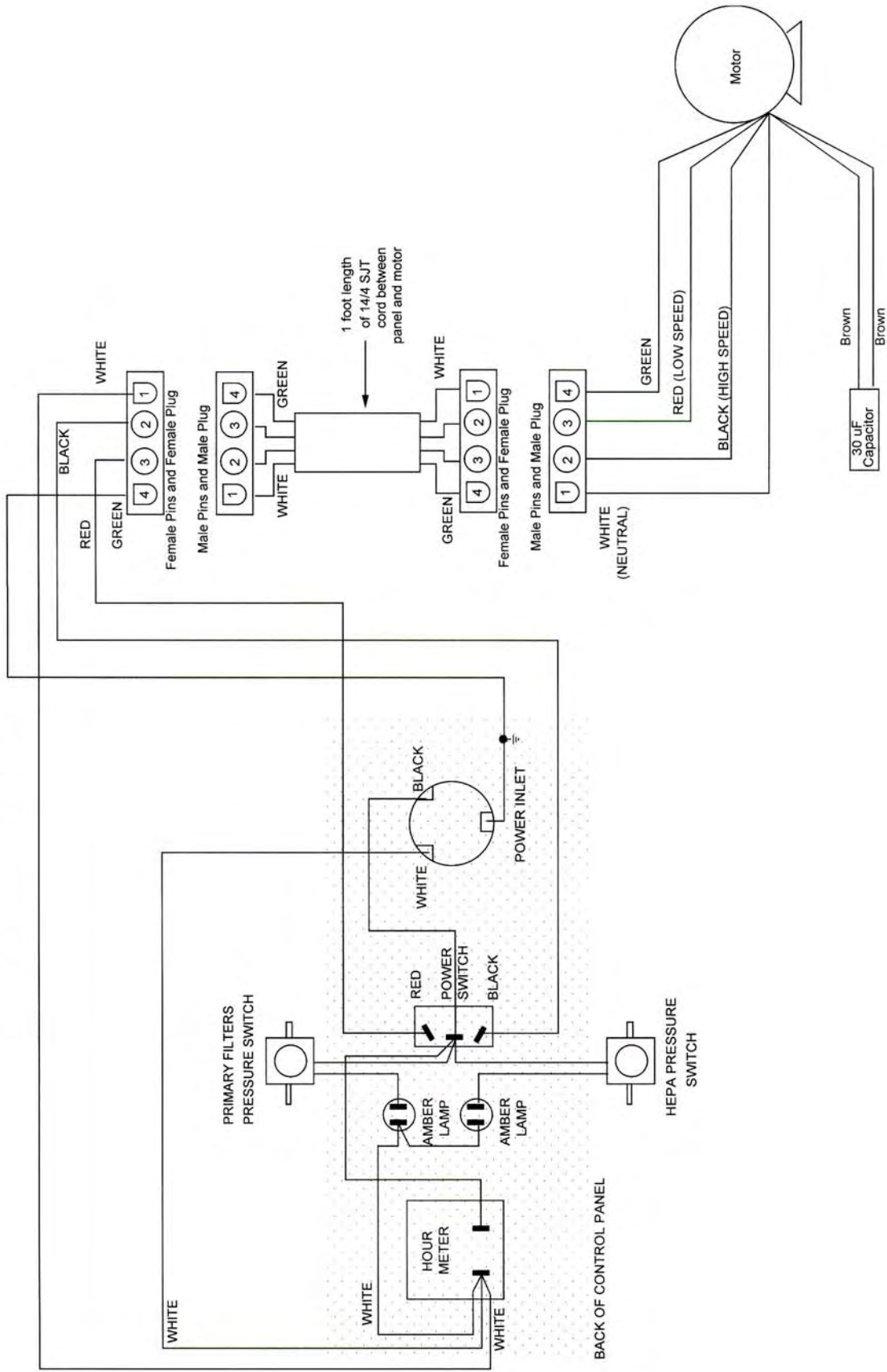

PAS18W12.DC2
MARCH 2003

ACTIVATED CARBON ADSORBENCY OF SELECTED SUBSTANCES AND ODORS

E= EXCELLENT

G= GOOD

P= POOR

NR= NOT RECOMMENDED

NOTE: SEE REVERSE SIDE FOR A MORE DETAILED EXPLANATION OF RATINGS.

Acetaldehyde	P	Chloropierin	E	Ethylene dichloride	E
Acetic Acid	E	Cigarette smoke odor	E	Ethylene oxide *	G
Acetic Anhydride	E	Cleaning compounds	E	Eucalyptole	E
Acetone	G	Coal smoke odor	G	Exhaust fumes	G
Acetylene	NR	Combustion odors	G	Fertilizer	E
Acrolein	G	Cooking odors	E	Film processing odors	G
Acrylic Acid	E	Corrosive gases	G	Fish odors	E
Acrylonitrile	E	Creosote	E	Floral scents	E
Adhesives	E	Cresol	E	Fluorotrichloromethane	G
Alines	P	Crotonaldehyde	E	Formaldehyde *	P
Ammonia *	P	Cyclohexane	E	Gasoline	E
Amyl acetate	E	Cyclohexanol	E	Glutaraldehyde *	P
Amyl alcohol	E	Cyclohexanone	E	Heptane	E
Amyl ether	E	Cyclohexene	E	Heptylene	E
Anesthetics	G	Decane	E	Hexane	G
Aniline	E	Decaying Substances	E	Hexylene	G
Antiseptics	E	Detergents	E	Hexyne	G
Asphalt fumes	E	Dibromoethane	E	Hospital odors	E
Benzene	E	Dichlorobenzene	E	Household smells	E
Bleaching solutions	G	Dichlorodifluoromethane	E	Hydrogen	NR
Body odors	E	Dichloroethane	E	Hydrogen bromide	G
Borane	G	Dichloroethylene	E	Hydrogen chloride	P
Bromine	E	Dichloroethyl ether	E	Hydrogen cyanide	G
Burned flesh	E	Dichloromonofluoromethane	G	Hydrogen fluoride	P
Butadiene	G	Dichloronitroethane	E	Hydrogen iodide	G
Butane	P	Dichloropropane	E	Hydrogen selenide	P
Butanone	E	Dichlorotetrafluoroethane	E	Hydrogen sulfide	G
Butyl acetate	E	Diesel fumes	E	Indole	E
Butyl alcohol	E	Diethylamine	G	Inorganic chemicals	G
Butyl cellosolve	E	Diethyl ketone	E	Iodine	E
Butyl chloride	E	Dimethylaniline	E	Idoform	E
Butyl ether	E	Dimethylsulfate	E	Isophorone	E
Butylene	P	Dioxane	E	Isoprene	G
Butyne	P	Dipropyl ketone	E	Isopropyl acetate	E
Butyraldehyde	G	Disinfectants	E	Isopropyl alcohol	E
Butyric acid	E	Embalming odors	E	Isopropyl ether	E
Camphor	E	Ethane	NR	Kerosene	E
Caprylic acid	E	Ether	G	Lactic acid	E
Carbolic acid	E	Ethyl acetate	E	Lubricating Oils & grease	E
Carbon disulfide	E	Ethyl acrylate	E	Medicinal odors	E
Carbon dioxide	NR	Ethyl alcohol	E	Menthol	E
Carbon monoxide	NR	Ethyl amine	G	Mercaptans	E
Carbon tetrachloride	E	Ethyl benzene	E	Mesityl oxide	E
Cellosolve	E	Ethyl bromide	E	Methane	NR
Cellosolve acetate	E	Ethyl chloride	G	Methyl acetate	G
Charred materials	E	Ethyl ether	G	Methyl acrylate	E
Chlorine *	G	Ethyl formate	G	Methyl alcohol	G
Chlorobenzene	E	Ethyl mercaptan	G	Methyl bromide	G
Chlorobuadiene	E	Ethyl silicate	E	Methyl butyl ketone	E
Chloroform	E	Ethylene	NR	Methyl cellosolve	E
Chloronitropropane	E	Ethylene chlorohydrin	E	Methyl cellosolve acetate	E

* Special adsorbent filter packs are available for these items. Call our Customer Service Department for additional information.

Methylchloride	G	Perfumes, cosmetics	E	Smoke	E
Methyl chloroform	E	Pet odors	E	Solvents	G
Methyl ether	G	Phenol	E	Spoiled food stuffs	E
Methyl ethyl ketone	E	Phosgene	G	Stoddard solvent	E
Methyl Formate	G	Pitch	E	Styrene monomer	E
Methyl ether	G	Plastics	E	Sulfur dioxide	P
Methyl mercaptan	E	Poultry odors	E	Sulfur trioxide	G
Methylcyclohexane	E	Propane	P	Sulfuric acid	E
Methylcyclohexanol	E	Propionaldehyde	G	Tar	E
Methylcyclohexanone	E	Propionic acid	E	Tarnishing gases	G
Methylene chloride	E	Propyl acetate	E	Tetrachloroethylene	E
Mildew	G	Propyl alcohol	E	Tobacco smoke odor	E
Mold	G	Propyl chloride	E	Toluene	E
Monochlorobenzene	E	Propyl ether	E	Toluidine	E
Monofluorotrichloromethane	E	Propyl mercaptan	E	Trichloroethylene	E
Ozone	E	Propylene	P	Trichloroethane	E
Packing house odors	E	Propyne	P	Turpentine	E
Paint & redecorating odors	E	Putrescine	E	Urea	E
Palmitic acid	E	Pyridine	E	Uric acid	E
Paradichlorobenzene	E	Resins	E	Valeric acid	E
Pentane	G	Rubber	E	Valeraldehyde	E
Pentanone	E	Sewer odors	E	Vinegar	E
Pentylene	G	Skatole	E	Vinyl chloride	G
Pentyne	G	Smog	E	Wood alcohol	G
Perchloroethylene	E	Soaps	E	Xylene	E

Some of the contaminants listed in the table use specific chemical compounds, some represent classes of components, and others are mixtures of variable composition. Activated charcoal's capacity for odors varies somewhat with the concentration of air, humidity, temperature, and with the actual velocity through the filters. The numbers given represent typical or average conditions and might vary in specific instances. The values in the table have been assembled from many sources including laboratory tests and field experience. In cases where numerical values were not available, the probable capacity based on general experience has been listed. This table should be used as a general guide only. The capacity index has the following meaning:

- E - Excellent adsorption of this substance. The activated charcoal will adsorb 20% to 50% of its weight of this substance.
- G - Good adsorption. Capacity is 10% - 20%.
- P - Generally poor adsorption. Under certain conditions, satisfactory performance is possible, but adsorption is very low (less than 10%).
- NR- Very poor adsorption. Use of activated carbon filters is not recommended for these substances.

WARNING: Any atmospheres containing combustible gases, oxygen-deficient gases, gases of an unknown origin and/or concentration, or gases exceeding permissible exposure level or threshold limit value must be properly identified by a certified professional and requires appropriate protection measures as indicated by the National Institute of Occupational Safety and Health (NIOSH) and the Mine Safety and Health Administration (MSHA). Use of carbon filters DOES NOT constitute a safe working environment.

- * Special adsorbent filter packs are available for these items. Call our Customer Service Department for additional information.