

# SAFETY, OPERATION AND MAINTENANCE MANUAL WITH PARTS LIST

Please read before use!

100 PSI



Model No. PE100

PROSPECTOR PE100 EXTRACTOR

# Jon-Don

## IMPORTANT INFORMATION AND SAFETY INSTRUCTIONS

Register your Machine at [www.jondon.com](http://www.jondon.com)

Serial No: \_\_\_\_\_

© 2013 Copy Rights Reserved Jon-Don, Inc.

- Reliable Power
- Innovative Design
- Safe & Easy to Use
- Powerful Extracting
- Easy Transport
- Patented Features

# **Jon-Don**

## **Dear Valued Customer,**

Congratulations on the purchase of your Prospector 100 carpet extractor! The world of carpet cleaning is becoming more high-tech and competitive and we strive to provide you with the most innovative products. Our carpet extractor is yet another example of this, bringing a new dimension to carpet and upholstery cleaning with its cutting-edge features, quality and value.

Please review this manual, paying careful attention to the "Safety Instructions" section. Keep in mind that any unnecessary damage, neglect or abuse of this machine will void your warranty. You can be confident that simple maintenance will ensure that your Prospector carpet extractor provides quality performance for many years to come.

If warranty questions arise, please consult your manual or contact your local Jon-Don store. Should you have any questions regarding maintenance, replacing parts, or ordering parts please call your local Jon-Don service department, or our technical support team at 800-556-6366 extension 8291.

Before you begin using your carpet extractor, please thoroughly review this owner's manual.

Again congratulations on the purchase of your Prospector 100 carpet extractor.

## **New Equipment Warranty**

Lifetime warranty on roto-molded body, 2-years on vacuum motors and 100 psi pump, 1-year on all electrical parts.

### **Warranty Policy**

All equipment is inspected and tested before shipping from the manufacturer. All parts are warranted to be new and free from defects in workmanship and material, under normal use to the original retail purchaser. This warranty limits manufacturer's liability for defects in workmanship or materials for replacement of defective parts only. The manufacturer accepts no liability for incidental or consequential damages arisen from the use of any equipment, defective or not. This warranty is in lieu of all expressed or implied warranties and is extended only to the original retail purchaser. Manufacturer sales and service representatives are not authorized to waive or alter the terms of this warranty, or to increase the obligations of the manufacturer under the warranty. Parts replaced or repaired under this warrant are warranted for the remainder of the original warranty period.

Freight charges and travel charges to and from the service provider shall be covered for ninety (90) days from the purchase date. After the ninety (90) day period, these freight charges shall be paid by the equipment owner, subject to manufacturer discretion. Certain circumstances may require additional consideration. No travel charges shall be covered after ninety (90) days.

The manufacturer covers up to one (1) year (365 days) of service labor at the manufacturer's calculated hourly labor rate/ repair time when performed by a manufacturer's authorized service provider. Ultimately, labor reimbursement costs are at the discretion of the manufacturer. After one (1) year, the original retail purchaser is responsible for all labor costs with no manufacturer reimbursement.

The warranty starts on the purchase date by the original purchaser from an authorized Jon-Don, Inc. distributor, subject to proof of purchase. The Machine Registration Form must be completed online at the time of purchase. If proof of purchase cannot be identified, the warranty start date is ninety (90) days after the date of sale to an authorized Jon-Don, Inc. distributor.

## 1.0 Safety Instructions

READ THIS MANUAL BEFORE USING YOUR CARPET EXTRACTOR. KNOW THE PROPER OPERATION, CORRECT APPLICATIONS AND THE LIMITATIONS OF THIS EQUIPMENT **BEFORE** USE.

### Reduce the Risk of Fire, Electric Shock or Injury:

- Use only as described in this manual. Use only the attachments recommended by the manufacturer.
- Test all outlets with an outlet tester before plugging machine into any outlet. Plug cord into the nearest grounded outlet.
- DO NOT unplug by pulling on the cord, grasp the plug. DO NOT pull unit by the cord.
- Keep cord away from heated surfaces.
- Never attempt adjustments or repairs while the machine is plugged in.
- DO NOT use if cord or plug are damaged.
- DO NOT use outdoors, in standing water on wet surfaces.
- Pay close attention when using machine near children.
- DO NOT pick up flammable or combustible materials or use machine where they may be present.
- DO NOT leave machine outdoors, in extreme heat or cold. Harsh weather elements will damage components and void warranty.
- Lift using only the appropriate handles.
- Always wear the appropriate clothing and safety equipment when operating the machine.
- Keep all body parts, hair and loose clothing away from openings and moving parts.
- Use extra care when cleaning stairs. Never move the machine up or down stairs with fluid in the machine.
- Use common sense to protect yourself and others from injury when using the machine.

## 2.0 Grounding Instructions

**DANGER: IMPROPER GROUNDING METHOD CAN RESULT IN A RISK OF ELECTRIC SHOCK.**

Electrical equipment must be grounded. If the machine should malfunction or breakdown, grounding provides a path of least resistance for electrical current to reduce the risk of electric shock. The Carpet Extractor is equipped with a cord containing a grounding conductor and grounding plug. The plug must be inserted into an appropriate outlet that is properly installed and grounded in accordance with all local codes and ordinances.

If repair or replacement of the cord or plug is necessary, DO NOT connect the grounded wire to a flat bed terminal. The grounding wire is the wire with insulation and an outer green surface, with or without yellow stripes.

### Grounding Method

The electric Carpet Extractor is for use on a normal 120 volt circuit. It has a grounded plug that fits the outlet illustrated in Figure A. If a properly grounded outlet is not available, a temporary adapter, such as the adapter illustrated in Figure B and C, may be used to connect the plug into a 2-pole outlet, as shown in Figure C.

The temporary adapter should be used only until a properly grounded outlet, Figure A, can be installed by a qualified electrician. The green colored rigid ear lug or grounding means extending from the adapter must be connected to a permanent ground, such as a properly grounded outlet box cover. Whenever the adapter is used, it must be held in place by its grounding means and a metal screw, as shown in Figure C.

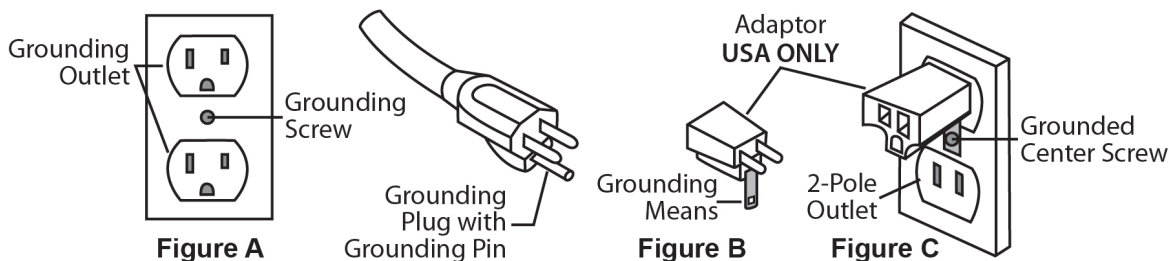



## 2.0 Grounding Instructions Continued

### WARNING:

Improper connection of the equipment grounding conductor can result in a risk of electric shock. Check with a qualified electrician or service person if you are in doubt as to whether the outlet is properly grounded. DO NOT modify the plug provided with the equipment. If it will not fit into the outlet, have a proper outlet installed by a qualified electrician.

NOTE: In Canada, the use of a temporary adapter is not permitted by the Canadian Electrical Code.

## 3.0 Set-Up / Prepare Unit for Use

DO NOT USE ON WET SURFACES. DO NOT EXPOSE TO RAIN. STORE INDOORS.

- All Carpet Extractors, no matter what the time of year, are shipped with antifreeze in the solution lines. Prior to first use, fill the tank with one gallon of warm water. Attach the hose and using the hand tool wand, flush out the system by spraying the one gallon of water through the pump.
- Attach the 1-1/2 inch vacuum hose and the brass quick disconnect.
- Fill the solution tank with warm water (less than 100 degrees Fahrenheit). Fill to approximately 4 inches from the top. Use a liquid detergent made for carpet cleaning or upholstery. Read and mix to the dilution ratios as directed.
- Do not use citrus acid, buterol or harsh degreasers inside the machine.

### 3.1 Power Priming the Solution Pump

Once water is in the solution tank, the solution pump must be primed:

- Turn ON both vacuums then the solution pump. The vacuum will pull solution through the pump into the vacuum tank.
- Connect the short prime hose that was included with your machine to the solution outlet quick connect and place the open end of priming hose inside the vacuum hose barb.
- Cup a hand around the hose and barb to increase the vacuum suction on the hose. When the pump is primed, you will hear the pulsation of the pump change.
- After priming, turn OFF the solution pump. Disconnect the prime hose and connect your solution hose and tool.

If the pump still does not prime or if flow is low or unsteady, check the hose from the solution tank to the pump (as well as the filter) for clogging, kinks or restrictions. Clean or replace hose and/or filter and repeat the priming process.

If you are having trouble with the pump, refer to the "Trouble Shooting Guide" section or contact the Jon-Don technical support team for advice or assistance.

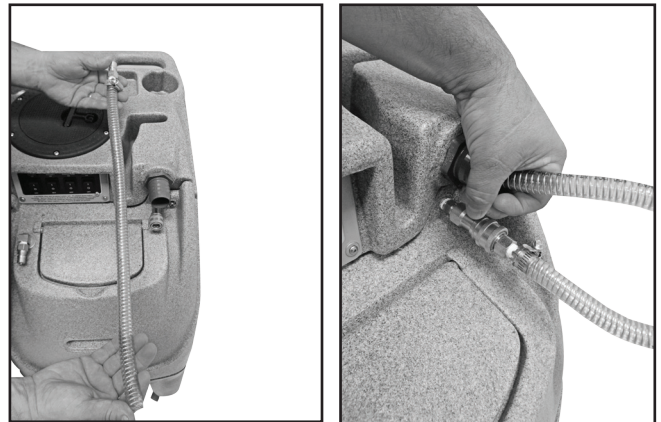

### 3.2 Electrical

Plug cord(s) into 20 AMP grounded wall outlet(s). 20 AMP circuits are normally found in kitchens and bathrooms. Never remove ground prong from the plug. If a circuit breaker trips during operation, turn machine off, reset the breaker and move the electrical cord to a different outlet and resume operation.

If moisture does enter the vacuum motors, contact your local Jon-Don service center. To prevent moisture from damaging the vacuum motors during storage, empty the recovery tank and store with the lid open.

## 3.0 Set-Up / Prepare Unit for Use Continued

### 3.3 Vacuum System

The extractor uses a dual vacuum motor system that provides outstanding water lift and air flow.

**Vacuum Float Assembly Warning System:** the float assembly on the vacuum stand pipe prevents the waste tank from overflowing the stand pipe and damaging the vacuum motors. Motors will reach a fast, high-pitched sound alerting you when the recovery tank is about to over flow. When this happens, immediately turn OFF the vacuum switches and empty the waste tank.

The float assembly has a filter to prevent lint and debris from entering the stand pipe. Refer to the “Maintenance” section for removal and proper cleaning.

**Recovery Tank:** An optional in-line filter (OE-ILF-EA) can be purchased and is recommended for use with all jobs.

It is also necessary to use a defoamer to eliminate foam build-up in the recovery tank which could lead to foam/moisture entering the vacuums and contributing to early failure of the vacuum motors.

If moisture does enter the vacuum motors, contact your local Jon-Don service center. To prevent moisture from damaging the vacuum motors during storage, empty the recovery tank and store with the lid open.

### 4.0 Shutdown Procedures

- If using the auto-fill system, turn the water supply OFF before finishing each job. This will allow use of the water and chemicals already in the tank and will reduce the amount of excess water to be disposed of later.
- When finished cleaning, turn OFF all switches.
- If the auto-fill system was used and there is still water in the solution tank, push the float down to release the water inlet hose pressure before disconnecting the hose from the faucet. Disconnect the water inlet hose from the quick disconnect on the front of the machine.
- Disconnect the solution hose and vacuum hose from the cleaning tool. Pull the valve trigger to release pressure from the hose before disconnecting the solution hose from the cleaning tool.
- Disconnect the clear view in-line filter from the vacuum hoses and clean the filter as needed.
- Disconnect the vacuum hose and solution hose from the machine.
- If water remains in the solution tank, use the short vacuum hose and vacuum the excess water from the tank.
- If the auto-fill system was utilized, place the chemical feed hose back into the solution tank.
- If the dump-out system was used: turn the waste pump switch ON to pump out any remaining water from the recovery tank; turn switch OFF, remove the dump pump-out hose from the outlet fitting and replace the cap; roll up the hose toward drain to remove the remaining water from the hose; connect ends of hose together to prevent dirty water from dripping from hose during transport.
- Disconnect the power cords from the outlets and from the machine.
- Remove the float assembly from the recovery tank and clean filter as needed. Replace float assembly and tank lid.
- Drain any remaining water from the recovery tank and dispose of in a sanitary drain. DO NOT use the same bucket to drain the tank that you used to fill the tank.
- Roll up all hoses and tools. Collect and store extractor, all tools and accessories.

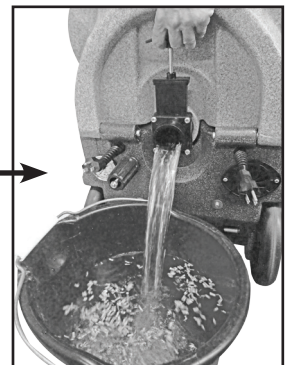
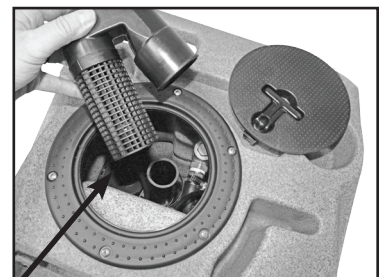
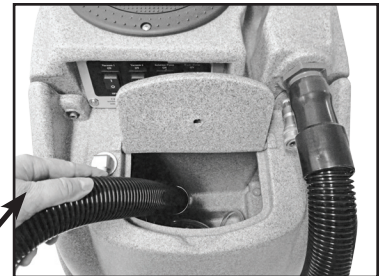

## 5.0 Maintenance

Regular maintenance is required to keep your Carpet Extractor in proper working condition. Failure to properly maintain your machine could void warranty. Thoroughly clean all equipment and accessories after each use:

- Rinse the solution and recover tanks with clean water.
- Flush the pump system with clean water, including all hoses and wand(s).
- Do not allow water to remain in the tanks after use.
- Lubricate all quick disconnects with WD-40 or similar lubricant.
- Clean vacuum float assembly screen.

**WARNING:** Disconnect electrical power cord before performing any service or maintenance inside the machine base or before testing or repairing switches or power cords. Failure to do so may result in severe personal injury or death.

Operation	Interval
Clean Chemical Feed Filter	Daily- After Each Job
Clean Vacuum Assembly Screen	Daily- After Each Job
Rinse Out Recovery Tank	Daily
Flush Solution Tank and Pump	Daily
Clean Pump-Inlet Filter	Weekly - As Needed

### 5.1 Clean Fresh Water Tank Filter

The fresh water tank filter is located at the bottom of the solution tank. Unscrew the filter counterclockwise and rinse with fresh water. If necessary, use a tooth brush to remove detergent build-up. Note, a heavy build-up is a warning sign that the solution system should be flushed. See the “Flush Chemical System” section.

### 5.2 Clean Vacuum Float Assembly Screen

Inside the recovery tank, on top of the stand pipe, is the vacuum float assembly. It functions to prevent debris and water from being sucked into the vacuum motors. Operating the Carpet Extractor without the float assembly or with a poorly maintained assembly, will greatly decrease the life of the vacuum motors and will void the warranty.

If debris builds up on this filter, it will reduce the vacuum air flow and may cause a significant decrease in the rate of water recovery. If debris prevents the float ball from moving or seating inside the assembly, it may not stop the airflow when the tank fills with water and the water will be sucked in the vacuums and blow out the exhaust.

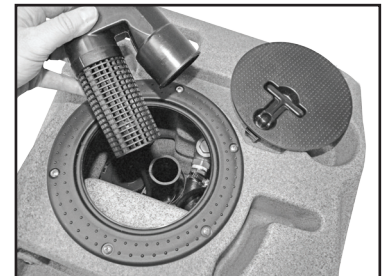

**Vacuum Float Assembly**

To clean, twist off the float assembly from the stand pipe and clean the screen. Pull fibers and lint off and rinse with clean water. Push the assembly back onto the stand pipe and replace the recovery tank lid.

This screen should be cleaned frequently if the Carpet Extractor is being operated in an environment which has an abnormal build-up of lint and debris, such as cleaning newly installed carpet. Loss of vacuum is most normally associated with lint build-up in this filter at the top of the vacuum stand pipe.

### 5.3 Rinse Out Recovery Tank

Build-up of fine silt and debris can damage the auto-dump pump and dump valve. Clean out the recovery tank on a regular basis to extend the life of these components as well as keep the tank and machine smelling better.

To rinse out recovery tank, remove the recovery tank lid and open the dump valve. Place a bucket under the dump valve. Use a hose to rinse the dirt and debris out of the recovery tank. Close the dump valve and spray the tank with deodorizer or disinfectant.

Proceed to waste pump cleaning and replace the recovery tank lid. Dispose of dirty water and debris.

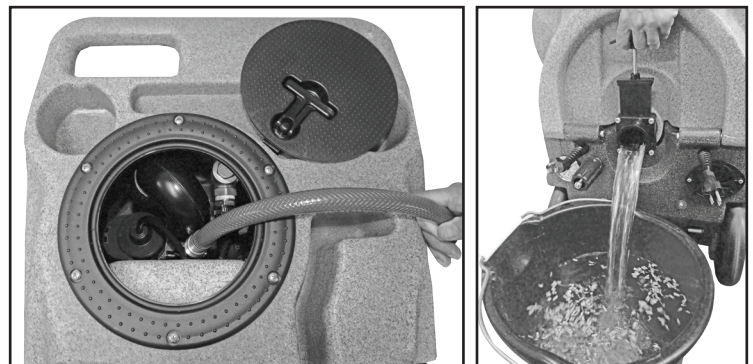



## 5.4 Clean Pump Inlet Filter

**CAUTION:** before proceeding with this procedure, make sure both the power cords are disconnected.

- To examine the filter, open the solution tank lid on the front of the machine. The filter is in the bottom of the solution tank.
- Grasp the filter cap and unscrew the filter from the brass nipple by turning counter-clockwise. Clean or replace the filter as needed.
- Tilt the tanks back onto the base and secure the latch.

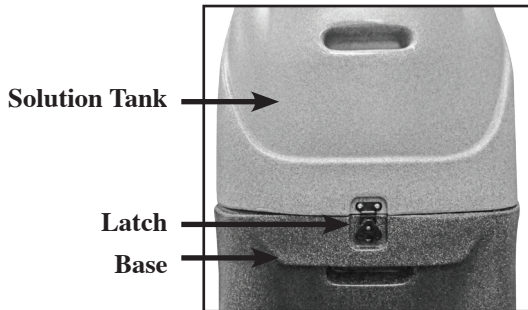

**1/4" Acorn Strainer**  
**Part No. 10-0845**

To prevent moisture from damaging the vacuum motors during storage, empty the recovery tank and store with the lid open.

## 6.0 Storage and Freeze Protection

You must winterize your Carpet Extractor to protect the pump system from freezing and also damage being caused to fittings and valves. Damage due to freezing is not covered under the Warranty. Store your extractor in temperatures over 40 degrees Fahrenheit. If you plan on storing your extractor in freezing conditions or for a long period of time, the following procedure should help prevent your Carpet Extractor from freezing and prevent pump and seals from drying out.

### Recommended Procedure for Storage

- In a separate container, mix 1/2-gallon of water with 1/2-gallon of automotive radiator antifreeze (ethylene glycol type). Mix well and pour into the solution tank.
- Connect the pressure hose to the female quick disconnect (QD) on the front of the machine. Insert an open-ended male QD into the female QD on the end of the pressure hose.
- When primed, turn down the pressure to 100 PSI.
- Disconnect the open-ended QD and connect the solution hose to the male QD at the auto-fill/chemical feed connection. **CAUTION:** applying high pressure (over 100 PSI) to the chemical feed system will damage the mechanism.
- With the chemical feed supply tube at the bottom of the solution tank, turn on the pump and allow to circulate for 10 minutes. Check to make sure the chemical supply tube is drawing the antifreeze solution. This will introduce antifreeze into the chemical feed system.
- Disconnect the solution hose from the chemical feed and allow the system to bypass for 10 minutes. This will work antifreeze into the pressure gauge.
- Attach wands and hand tools that will also be stored with the Carpet Extractor. Open the valve for 30 seconds, directing the spray to the solution tank. Disconnect the hose and with the valve open and the jets pointing down, depress the dimple on the male QD. This will drain the solution out of the tool. Drain thoroughly before storing.
- Turn off the pump and disconnect all hoses and tools. Vacuum out the solution tank and thoroughly drain the recovery tank and vacuum hose.

**To return to service, flush the pressure system by repeating the above steps, using fresh water in place of antifreeze.**

## 7.0 Trouble Shooting Guide

Never operate this Carpet Extractor when the equipment is not performing as expected or when any part is visibly damaged. When repair is needed, take the equipment to an authorized service center.

System	Problem	Possible Cause	Remedy
<b>Vacuum System</b>	No Vacuum / Weak Vacuum	<ol style="list-style-type: none"> <li>1. Vacuum Tank Full</li> <li>2. Float Assembly Tank Screen Dirty</li> <li>3. Float Ball Stuck</li> <li>4. Damaged or Loose Vacuum Hose</li> <li>5. Dump Valve Open</li> <li>6. Access Lid not Sealed</li> <li>7. Vacuum Hose Clogged</li> <li>8. Air Intake Grid Clogged</li> <li>9. Leak in Recovery Tank</li> <li>10. Water Coming out of Vacuum Exhaust</li> </ol>	<ol style="list-style-type: none"> <li>1. Empty Tank</li> <li>2. Clean the Screen with Water</li> <li>3. Tap Float to Unstick then Clean</li> <li>4. Attach or Replace</li> <li>5. Close Valve</li> <li>6. Replace Gasket</li> <li>7. Clear Debris</li> <li>8. Clean</li> <li>9. Clean and Dry Area, Patch with Silicone</li> <li>10. Use a Low Foaming Detergent</li> </ol>
<b>Electrical System</b>	Unit will not Turn On	<ol style="list-style-type: none"> <li>1. Extension Cord not Plugged In</li> <li>2. Switch not in the "On" Position</li> <li>3. Building Circuit Overloaded</li> <li>4. Wiring Connections Loose</li> </ol>	<ol style="list-style-type: none"> <li>1. Check if Machine and Cord are Plugged In</li> <li>2. Check Switches, Replace if Necessary</li> <li>3. Reset Circuit</li> <li>4. Unplug Machine and Check for Loose Wires</li> </ol>
	Burning Smell	<ol style="list-style-type: none"> <li>1. Vacuum Motor Hung Up</li> <li>2. Pump Motor Hung Up</li> </ol>	<ol style="list-style-type: none"> <li>1. Replace Vacuum Motor</li> <li>2. Replace Pump</li> </ol>
<b>Pump System</b>	Pump is not Running Properly	<ol style="list-style-type: none"> <li>1. No Power to the Pump</li> <li>2. Jets on Wand are Clogged</li> <li>3. In-Line Water Filter is Clogged</li> <li>4. Debris in Solution Tank Covering Inlet</li> <li>5. Kinked or Loose Hose</li> <li>6. Pump Failed</li> <li>7. Quick Disconnects are not Completely Locked Together</li> <li>8. Heater is Clogged with Deposits</li> <li>9. Pump is Pulsating</li> <li>10. Auto Prime Valve is Open</li> </ol>	<ol style="list-style-type: none"> <li>1. Check the Electrical System</li> <li>2. Clean Jet Filters</li> <li>3. Clean In-Line Filter</li> <li>4. Clear Debris</li> <li>5. Check and Replace Hoses if Necessary</li> <li>6. Replace Pump</li> <li>7. Snap Quick Disconnects Together\</li> <li>8. Flush Heater with System Maintainer or Replace if Necessary</li> <li>9. Check for Clogged Jets and Clean</li> <li>10. Close Valve</li> </ol>



## 8.0 Machine Schematic Drawing

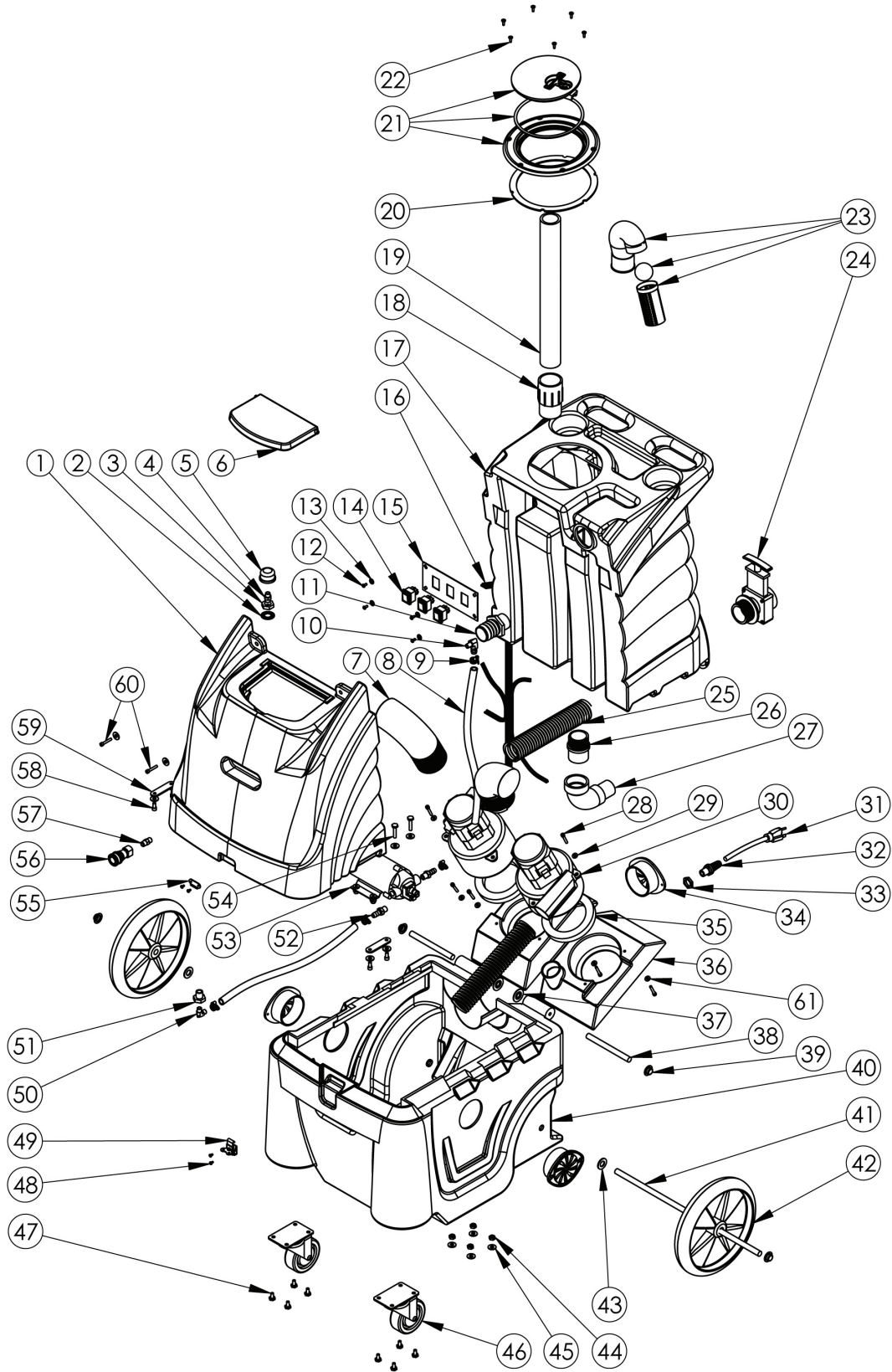

## 9.0 Machine Parts List

Drawing No.	Item ID	Item Description	Qty.
1	SN-12-ST-BLUGRAN	12-Gallon Solution Tank - Blue Granite	1.00
2	Part of Solution Tank	Inserted Molded in to Solution Tank	
3	80-0017	Bulk Head Fitting for Extractor	1.00
4		Part of 80-0017 Bulk Head Fitting	
5	10-0845	1/4" Strainer for Extractor	1.00
6	SN-12-L-BLUGRAN	12-Gallon Lid - Blue Granite	1.00
7	80-0001	Extractor Exhaust Hose	0.40
8	10-0843-COM	3/8" x 48" Black Hose Complete with Fittings and Clamps	2.00
9	10-0826	Clamp - Part of 10-0843-COM	
10	80-0026	3/8" Barb x 1/4" MPT 90 Degree Part of 10-0843-COM	
11	10-0806	Barb Hose Fitting for Extractor	1.00
12	10-0379	8-32 x 3/8 Screw	8.00
13	10-0204	Motor Mount Back-Up Washer	18.00
14	10-0803	Splash-Proof Switch for Extractor	3.00
15	10-0809	Extractor 3-Hole Switch Plate	1.00
16	80-0200	Extractor Harness	1.00
17	SN-12-RT-BLUGRAN	12-Gallon Recovery Tank - Blue Granite	1.00
18	80-0008	1.5 PVC Female Adapter	2.00
19	10-0416-A	1-1/2" Black ABS Stand Pipe	2.60
20	10-0804-A	Hatch Cover Gasket for Extractor	1.00
21	10-0804	Hatch Cover for Extractor	1.00
22	10-0419-A	Screw for Extractor Hatch	12.00
23	80-0012	Float Assembly for Extractor	1.00
24	10-0805	Dump Valve for Extractor	1.00
25	10-0024	1-1/2" Black Vacuum Hose	1.30
26	10-0849	1-1/2" ABS Fitting	1.00
27	10-0848-B	1-1/2" 90 Degree ABS Street Elbow	3.00
28	10-0833	Motor Manifold Bolts for Extractor	10.00
29	10-0204	Motor Mount Back-Up Washer	18.00
30	10-0811	2-Stage Extractor Motor	2.00
31	10-0838-A	Complete Pigtail for Extractor	1.00
32	10-0850	Strain Relief for Pigtail - Part of 10-0838-A	
33	10-0851	Strain Relief Nut for Pigtail - Part of 10-0838-A	
34	10-0822	Exhaust Grate for Extractor	3.00
35	10-1030-S2	2-Stage Extractor Motor Gasket	2.00
36	SN-12-MFLD	Extractor Motor Manifold	2.00
37	10-0830	Hinge Keeper for Extractor	2.00
38	10-0821	Extractor Hinge	2.00
39	10-0820	End Cap for Rod on Extractor	4.00
40	SN-12-MB-BLKGRAN	12-Gallon Motor Base - Black Granite	1.00
41	10-0836	19" Axle for Extractor	1.00
42	10-0807	Wheels for Extractor	2.00
43	10-0840	Nylon Washer for Extractor Axle	8.00
44	10-0835-N	Nut for Pump Bolt on Extractor	4.00
45	10-0834	Pump Flat Washer	10.00
46	10-0808	Caster for Extractor	2.00
47	10-0816	Caster Bolt	8.00
48	10-0379	8-32 x 3/8 Screw	8.00
49	10-0400-D	Latch for Extractor	1.00
50	80-0026	3/8" Barb x 1/4" MPT 90 Degree - Part of 10-0843-COM	
51	10-0823	3/8" Barb x 3/8" Male - Part of 10-0843-COM	
52	10-0823	3/8" Barb x 3/8" Male for Extractor	2.00
53	10-0812	100 psi Extractor Pump	1.00
54	10-0835-B	Pump Bolt 100 psi Extractor	4.00
55	10-0400-C	Keeper Latch for Extractor	1.00
56	10-0868	1/4" Female QD for Extractor	1.00
57	10-0846	1/4" MPT Hex Nipple for Extractor	1.00
58	10-0832	S/R Strap Bolts	4.00
59	10-0831	S/R Bracket for Extractor	2.00
60	10-0818	S/R Top of Tank Bolt on Extractor	2.00
61	10-0023	Shoulder and Waist Belt Washer	4.00

**Notes:**



# PROSPECTOR PE 100 EXTRACTOR

By Jon-Don, Inc.

Please fill out the following information:

Model No: \_\_\_\_\_

Serial No: \_\_\_\_\_

Distributor Name: \_\_\_\_\_

Distributor Phone No: \_\_\_\_\_

Date of Purchase: \_\_\_\_\_



Built With Pride  
in the USA

# **Jon-Don**

400 Medinah Road, Roselle, IL 60172

Phone: 800-556-6366 | Fax: 888-344-6878

[www.jondon.com](http://www.jondon.com)