

Turbo-Hybrid TH-40

Owners Manual

Specification:

- Designed for cleaning ceramic tile and grout with your truckmount or high pressure portable.
- Brush attachment allows for use on other flooring.
- Cleaning capacity 400 to 1000 square feet per hour depending on build up and texture of surface.
- Lightweight but solid, resistant to impact.
- Stainless steel handle with fiber reinforced shell.
- Extra long life boot with NEW brush attachment.
- Operating pressure range 650 to 2500 psi.
- Water temp. up to 230°
- Comfort grip non-slip handle
- Patented automatic vacuum compensator leaves the floor drier.

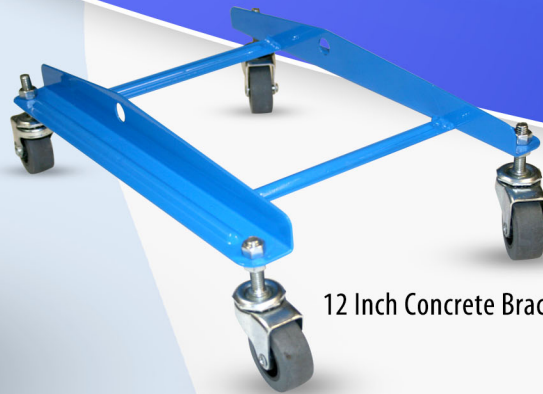

12 Inch Concrete Bracket Attachment (optional)

**TF TURBO
FORCE**
INTERNATIONAL

John 14:6

1.800.353.6382 | ronb@turbo-force.com | turbo-force.com

7905 N. 71st Ave. Glendale, AZ 85303

Turbo-Hybrid TH-40

Owners Manual

Limitation of Liability

Turbo Force International's (T.F.I.) liability on any claim for loss or damage connected with the supplying of goods, or their sale, resale, operation, or use, warranty, tort (including negligence) or other grounds, shall not exceed the price allowable to such goods or part thereof involved in any claim.

T.F.I shall not under any circumstances be liable for any labor charges, special or consequential damages including, but not limited to, bodily injury, loss of profits or revenues, loss of use of any product or associated product, cost of capital, cost of substitute products, facilities or services, downtime costs or costs of claims arising from Buyer or Buyer's customers.

Any technical advice or assistance furnished by Turbo Force International which concerns any goods supplied here under, will not subject T.F.I to any liability, whether based on contract, warranty tort (including negligence) or other grounds.

***Do not put your hands under the deck while the tool is in use and after the trigger handle is released (wait 2 minutes for the spray bar to completely stop) failure to do so can cause serious injury and Turbo Force International will not be held liable for disregarding this warning which results in any but not limited to injuries, damage, loss of limbs and or life.**

Warranty:

Turbo-Force International warrants that its product(s) (the Product) shall be free from defects in materials and workmanship under normal use, installation and maintenance in accordance with T.F.I. specifications for a period of 1 year from the date of purchase. If any failure to conform to this warranty is reported to T.F.I. within 1 year from the date of purchase by the original buyer, T.F.I., upon being satisfied of the existence of such non-conformity, will, with exclusions (wear and tear) etc., correct same at its discretion by repairing or replacing the Product.

Exclusions:

The swivel (T-8a) is a sealed item it will not be covered if factory seal is broken from improper adjustment or installation. Swivel must be returned to T.F.I. for evaluation. Swivel will be repaired or replaced at manufacturer's discretion. Swivels that show signs of abuse or misuse will not be warranted. Interface ring or "boot" (T-260 or T-270b) is covered from breakage or defect only for 90 days; there is no warranty against wear. Vacuum hoses, high pressure lines, and fittings are not covered under this warranty.

This warranty does not cover damage resulting from mishandling in transit, vandalism, misuse, abuse, neglect, alteration, dismantling, excess heat, acts of God or failure to exercise reasonable care in using or maintaining the Product. This warranty applies only to the original purchaser / owner of the Product. Original sales receipt / sales contract is required to validate warranty. To obtain service under this warranty, contact your dealer.

This warranty is in lieu of and excludes all other warranties, express or implied, arising by operation of law or otherwise, including any warranty of merchantability or fitness for particular purpose or otherwise, and no representation of warranty, expressed or implied, made by any sales representative or other agent of T.F.I.. In no event shall T.F.I. be liable for incidental or consequential damages.

This warranty gives you specific legal rights which may vary from state to state.

Turbo-Hybrid TH-40

Owners Manual

Care and Repair

1. Keeping a clean supply going into your truck mount will minimize problems.
2. Check and clean the steel mesh filter just after the quick connect fitting using two wrenches. It is important to check and clean the filter screen frequently, as a dirty filter will drastically reduce tool efficiency.
3. Your Turbo has an automatic patented vacuum compensator mounted on the bottom side of the deck. The deck relief is pre-set to most job situations and should not need further adjusting, however, using two wrenches, the vacuum relief tension spring can be adjusted to your truck mount's performance.
4. The new ceramic seal swivel has a weep hole to indicate when it is time to replace the seals. A seal rebuild kit is available separately from your dealer. If the seals are worn and water is allowed to enter the bearing surfaces, damage to the bearings will occur and the swivel will need to be replaced. See figure (3) for more details.
5. Keep the swivel mounting nuts tight, as a loose spinner will reduce efficiency of the tool.
6. The glide boot on your Turbo is constructed of a very abrasion resistant plastic and should give long life. A brush ring is included for certain types of flooring such as marble, travertine and other softer materials that could be scratched from grit caught under the hard boot.
* The Hybrid brush ring has a vinyl skirt that maintains proper air flow leaving the floor drier.
7. When excessive wear occurs, the boot should be replaced. See below for boot replacement instructions. Using your Turbo with a badly worn boot, will tend to catch some tile edges. **Floor damage will occur if you allow the boot to wear so thin that the spinning jets contact the floor.**
8. Use the vacuum relief slider on the stainless tube to adjust for very smooth floors or truck-mounts with extreme suction.

* It is up to the operator to decide what kind of flooring can be cleaned. Turbo Force Int'l. makes no warranty or claims as to the specific types of flooring that can be cleaned. Turbo Force Int'l shall not be held liable for any damage or injury claims resulting from the use, misuse or abuse of the cleaning tools. There is always a risk of floor damage when using extreme pressure and heat. Experience and proper training are essential to avoid costly damage claims including scratching of softer stone or other surfaces.

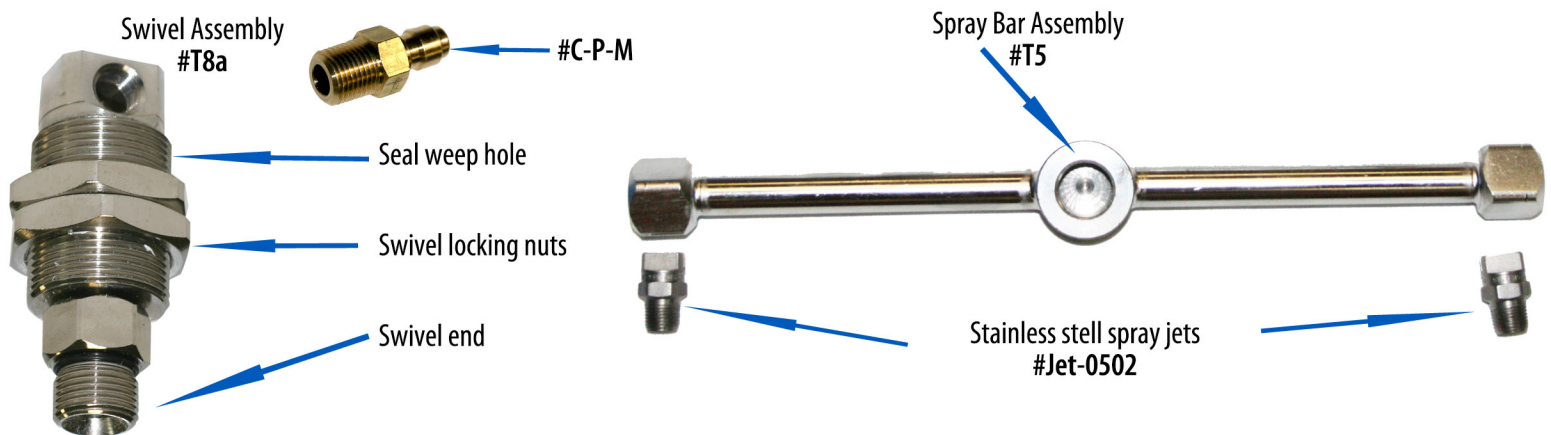

Swivel Replacement Instructions

To replace swivel, start by removing hose from compression fitting. Turn tool over and using a stubby 3/4" open end wrench, hold spray bar nut while turning spray bar assembly (right hand thread). Loosen and remove top swivel lock nut. Remove swivel out through the bottom of the deck. (Do not use Top Flats on the swivel as wrench points for removing or tightening the lock nuts. You can damage the swivel by doing so. **Place the upper lock nut so 1 or 2 threads are exposed above nut body before installing it in the deck.** Tighten the swivel lock nuts. Install the spray bar by holding the spray bar nut with stubby 3/4" open end wrench and spinning the spray bar on. It is self seating and needs only to be hand tightened to "o" - ring. Do not use thread seal. Check that spray bar spins freely and jets are recessed approx 1/4" below inner deck edge. Install the pressure line and tighten the swivel hose nut. Do not over tighten as this is a compression fitting. Test and check for leaks. **Do not aim Turbo at anyone as high pressure water can cause serious injury!**

1.800.353.6382 | ronb@turbo-force.com | turbo-force.com

7905 N. 71st Ave. Glendale, AZ 85303

Turbo-Hybrid TH-40

Owners Manual

TS-11 Ceramic Seal Replacement Kit

There is a seal kit available for the T-8a swivel that replaces the "O" rings and the ceramic seals. It is intended to repair swivels that still spin freely, but have developed a leak visible at the weep hole. If a leaky swivel is not repaired, water can enter the bearing chamber and the swivel will need to be replaced.

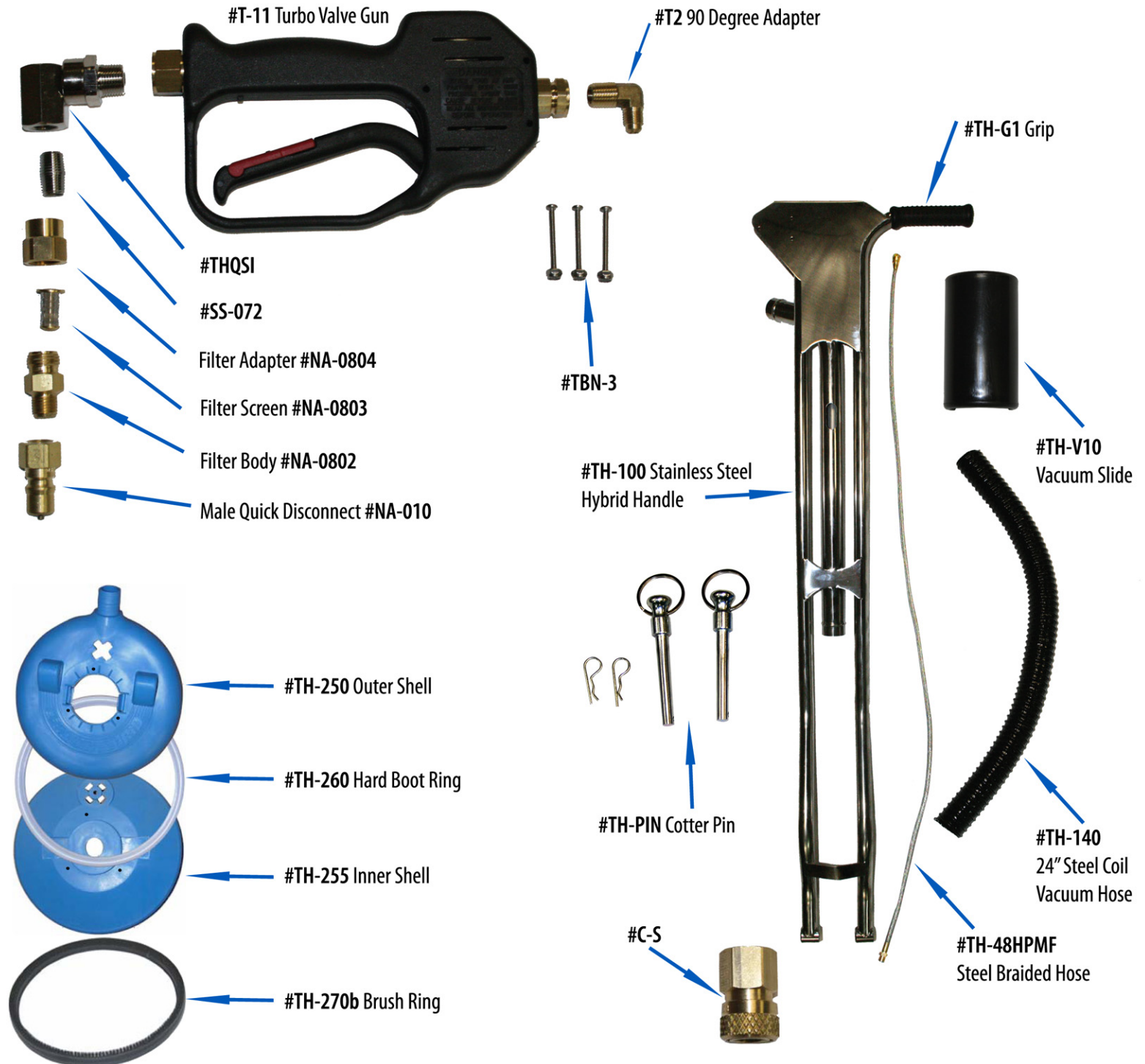

1.800.353.6382 | ronb@turbo-force.com | turbo-force.com

7905 N. 71st Ave. Glendale, AZ 85303

Turbo-Hybrid TH-40

Owners Manual

12 inch Concrete Bracket Attachment

#TH-PIN Cotter Pin (2 Pins)



#HT-C (4 Wheels with Nuts)



#TH-12CA Concrete Bracket

1.800.353.6382 | ronb@turbo-force.com | turbo-force.com

7905 N. 71st Ave. Glendale, AZ 85303

Turbo-Hybrid TH-40

Owners Manual

Turbo disassembly and replace boot ring or bursh ring



Step 1: Undo the high pressure line at the swivel.

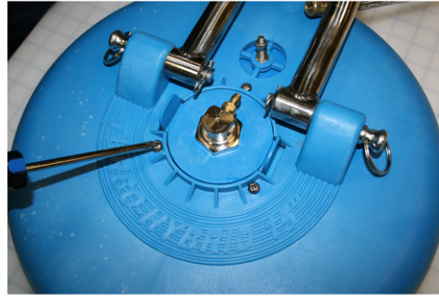

Step 2: Remove the 3 screws on top of the turbo deck with a Phillips screwdriver.

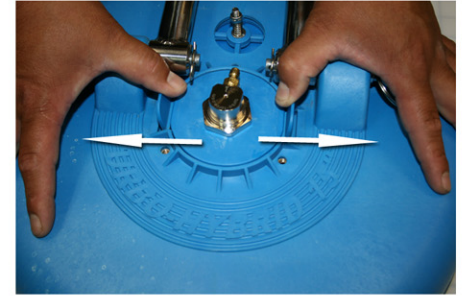

Step 3: Pull both of the deck locking tabs.

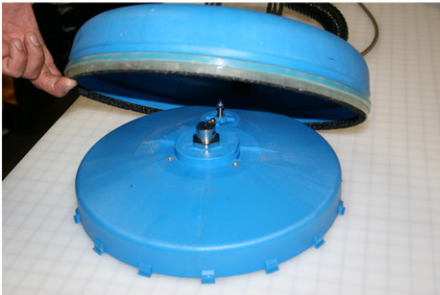

Step 4: Once you pull the deck locking tabs, the inner shell should just come off.

Step 4b: This step is where you can remove and replace the boot ring or bursh ring.

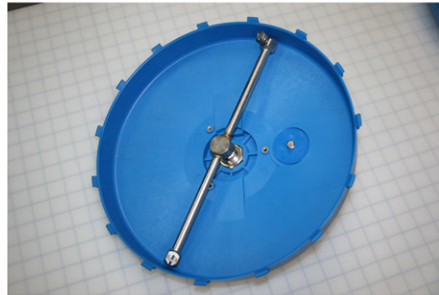

To remove Spray bar: Use a 3/4" wrench to hold the swivel nut, grab the spraybar and loosen.(right hand thread)



Reverse in order to put back...

To check for proper jet operation, turn the tool upside down, grab the spraybar securely, and with high pressure source hooked up, pull the trigger. Point jets away from face while observing spray pattern. You should see 2 well defined, flat, narrow fans. If not one or both jets may be clogged and will need to be cleaned. Sometimes a very fine wire bristle inserted into the orifice can clear a clogged jet. Be careful not to score or damage the orifice. Badly clogged jets need to be removed from the elbows, blown out and inspected. The jets can wear out over time depending on pressure, heat and mineral content in the water. Make sure you are using filters on your water supply and check the Turbo's inline filter screen after heavy usage.

Turbo-Hybrid TH-40

Owners Manual

Installing 12" Concrete Attachment Bracket



Step 1: Undo the high pressure line at the swivel and remove cotter pins.



Step 2: Lift the handle off of the turbo deck. Place the concrete bracket on the of the turbo deck. Make sure the holes align.

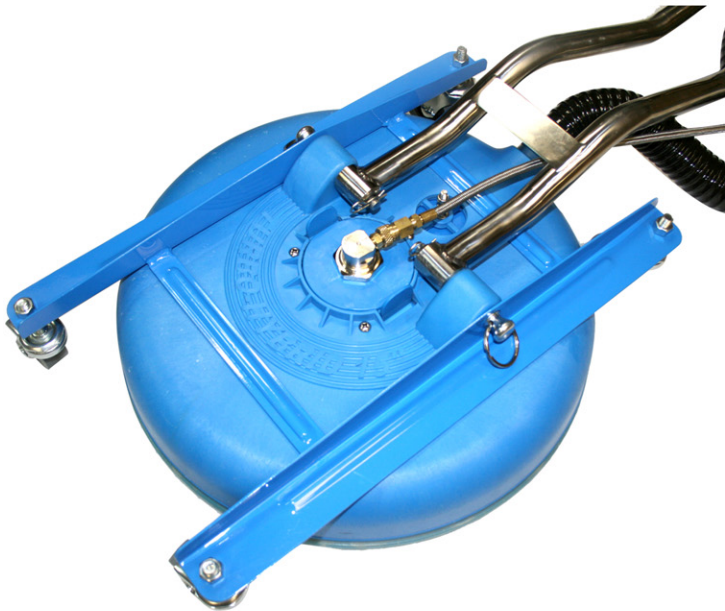

Step 3: Place cotter pin back in place. Securely connect the quick disconnect back on the swivel.

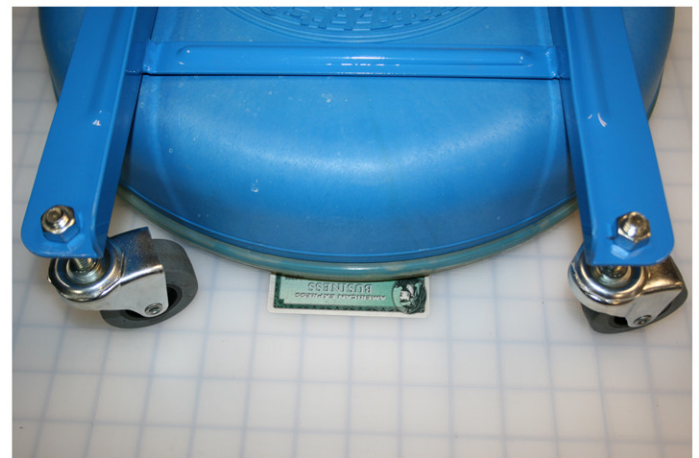

Step 4: Just the caster wheel so the boot ring or bursh ring is about the height of a credit card.

1.800.353.6382 | ronb@turbo-force.com | turbo-force.com

7905 N. 71st Ave. Glendale, AZ 85303